

(27-28)

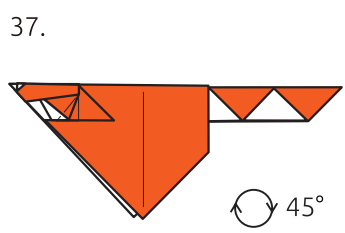

45°

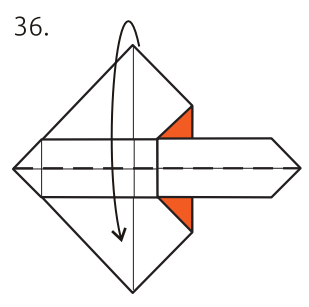
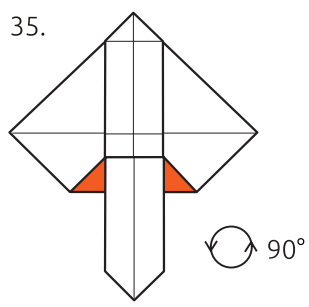
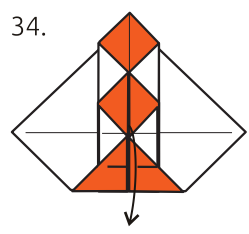
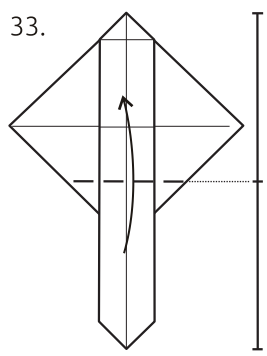
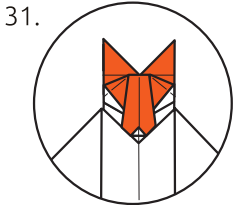
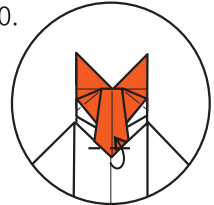